



INSTALLATION INSTRUCTIONS

Thrasher Board

APPLICATION:

2009-2015 Ram Quad/Crew Cab 1500, 2500, 3500

AUTOMOTIVE PRODUCTS,

PART NUMBER:

28-81045, 28-81055

CONTENT			
ITEM	QUANTITY	DESCRIPTION	TOOLS NEEDED
1	2	STEP BAR ASSEMBLY	13MM SOCKET
2	3	MOUNTING BRACKET A	13MM WRENCH
3	2	MOUNTING BRACKET B	10MM SOCKET
4	1	MOUNTING BRACKET C	10MM WRENCH
5	6	PLASTIC BRACKET COVER	17MM SOCKET
6	6	M8 HEX RIV-CERT (YELLOW ZINC)	17MM WRENCH
7	6	M10 HEX NUT (YELLOW ZINC)	M4 ALLEN WRENCH
8	6	M10 SPLIT LOCK WASHER (YELLOW ZINC)	ALLEN KEY
9	6	M10 FLAT WASHER (YELLOW ZINC)	DRILL
10	6	M10 STUD / M8 NUT PLATE (YELLOW ZINC)	1/4" DRILL BIT
11	12	M6 HEX HEAD CAP SCREW (YELLOW ZINC)	5/16" DRILL BIT
12	24	LARGE M6 FLAT WASHER (YELLOW ZINC)	RATCHET
13	12	M6 NYLOCK NUT (YELLOW ZINC)	TORQUE WRENCH
14	12	M8 HEX HEAD CAP SCREW (YELLOW ZINC)	
15	12	M8 SPLIT LOCK WASHER (YELLOW ZINC)	
16	12	M8 FLAT WASHER (YELLOW ZINC)	
17	2	M6 BUTTON HEAD CAP SCREW (BLACK ZINC)	
18	2	M6 SERRATED FLANGE NUT (BLACK ZINC)	
19	2	SMALL M6 FLAT WASHER (BLACK ZINC)	
20	12	M8 HEX NUT (BLACK ZINC)	
21	12	M8 SPLIT LOCK WASHER (BLACK ZINC)	
22	12	M8 FLAT WASHER (BLACK ZINC)	
23	6	M10 PLASTIC RETAINER SQUARE (BLACK ZINC)	
24	6	M8 BOLT PLATE	

ANTI-SEIZE LUBRICANT MUST BE USED ON ALL STAINLESS STEEL FASTENERS TO PREVENT THREAD DAMAGE AND GALLING

PROCEDURE

1. Remove contents from box, verify if all parts listed are present and free from damage.
Carefully read and understand all instructions before attempting installation.
Failure to identify damage before installation could lead to a rejection of any claim.



Westin Automotive Products, Inc.
320 W. Covina Blvd
San Dimas, Ca. 91773

P.N.: 75-1541-RevA

ECO #: W15-0120

Thank You for choosing Westin products
For Additional installation assistance please call

Customer service (800) 793-7846

www.westinautomotive.com

DATE: 12/09/15

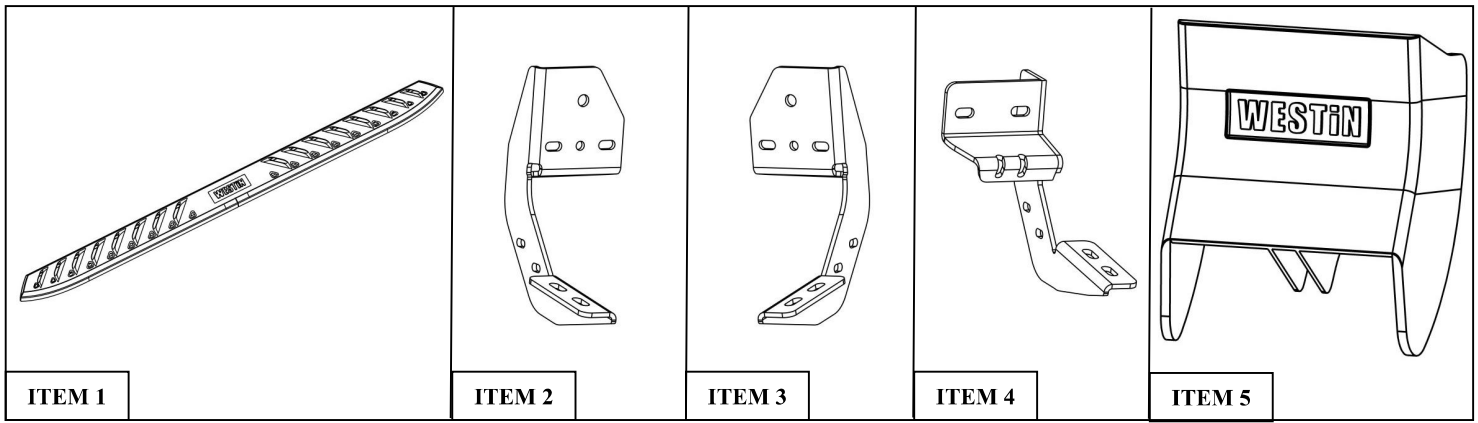

2. Check either side of the vehicles rocker panel, locate the factory holes in the rocker panel by removing the tape. Check and verify what type of rocker panel you have. **See Figure. 1, 2, 3, & 4.** **Note:** If any of the locations on the factory holes in the rocker panel have factory M8 riv-certs or threaded M8 holes, do not use provided M8 riv-certs (item 6) in that location. **Refer to Figure. 1, 2, 3 & 4.**
3. **Starting from the driver side:** If the threaded holes are not present use (2) M8 riv-certs (item 6) and insert them into the hex holes. **Note:** See Figure 6 for example on how to tighten M8 riv-certs, it will require to use an M10 bolt with M8 nut plate (item 10) along with a bracket A or B to perform this task. This procedure will permanently install M8 riv-cert. **See Figure 11** on how to install M10 nut M8 bolt plate to install bracket C, **Note:** The M10 bolt portion of the bolt plate will not be utilized for bracket C, only the M8 nut portion will be used.
4. Proceed to install Mounting Bracket C (item 4) onto the rocker panel by using (2) M8 hex cap screw (item 14), (2) M8 lock washers (item 15), (2) M8 flat washers (item 16). For the pinch weld, attach bracket (item 4) by using (2) M6 Button head bolts, (2) M6 flat washers & (2) M6 serrated flange nuts (items 17-19). **Note:** Drilling of two 1/4" holes might be necessary on pinch weld if factory holes are not present. Before drilling place masking tape on drill surface to prevent paint chipping. Drilling will be necessary for the other mounting locations on pinch weld. **See Figure. 9 & 10.**
5. On the center and rear mounting locations of drivers side attach (1) M8 riv-cert to rocker panel if not already present. Then proceed to install (1) M10 bolt/M8 nut plate (Item 10) into the rocker panel and thread (1) M10 plastic retainer (Item 23) to the M10 bolt to prevent it from falling into the rocker panel. **See Figure. 5.**

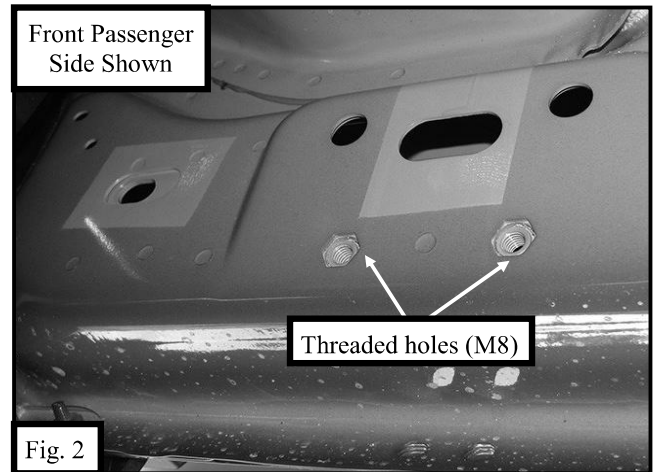
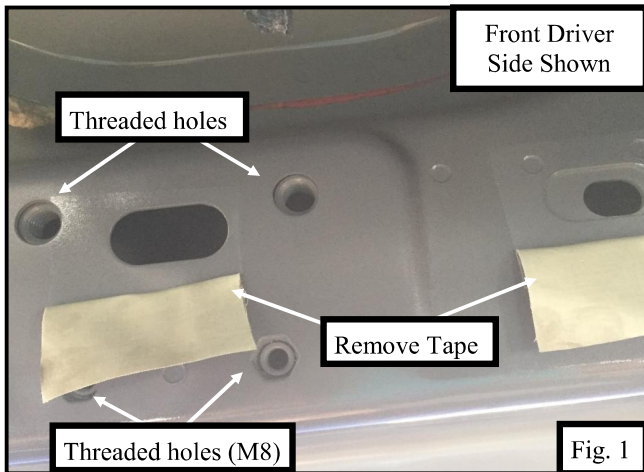

Westin Automotive Products, Inc.
320 W. Covina Blvd
San Dimas, Ca. 91773

P.N.: 75-1541-RevA

ECO #: W15-0120

Thank You for choosing Westin products
For Additional installation assistance please call
Customer service (800) 793-7846
www.westinautomotive.com

DATE: 12/09/15

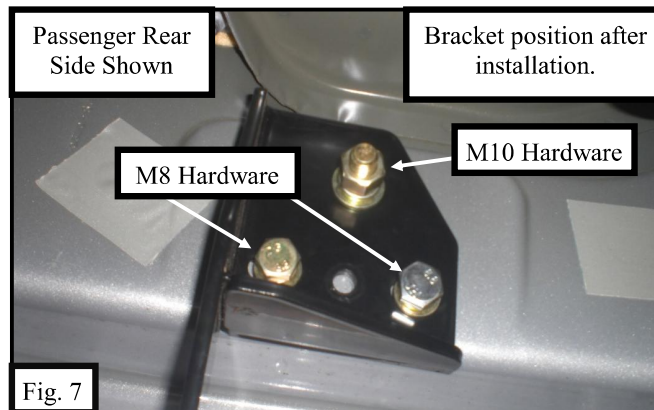
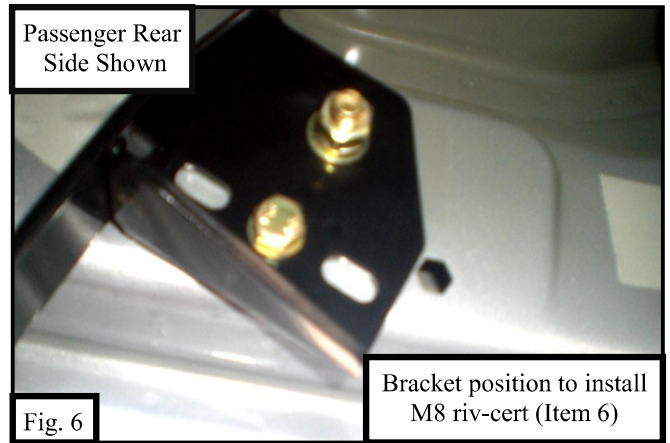
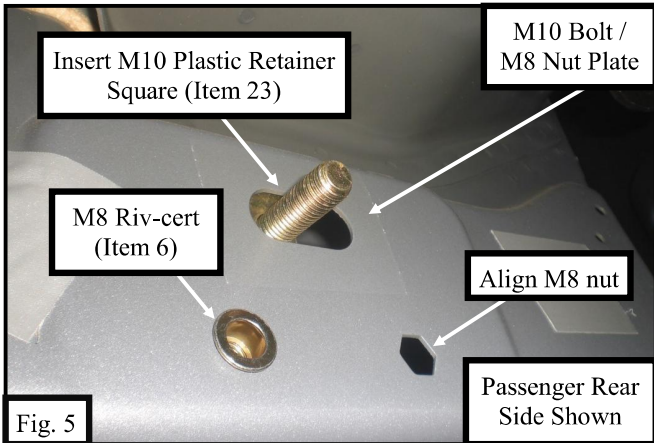
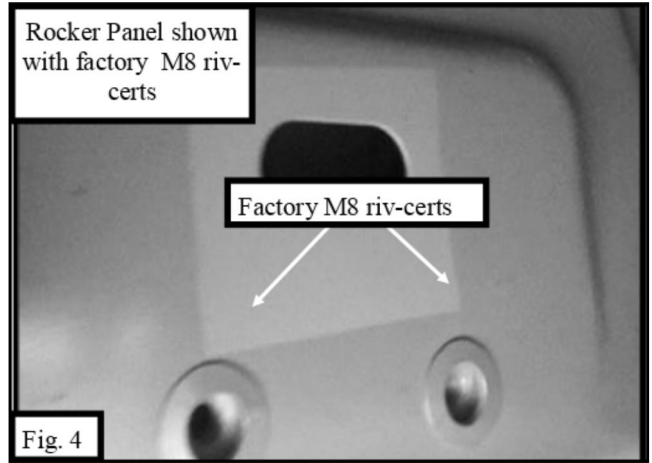
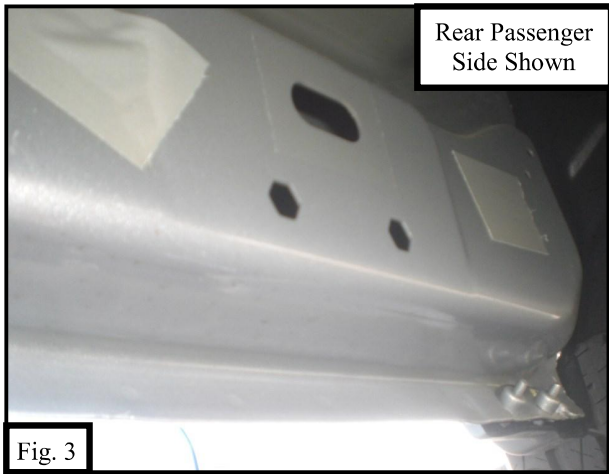

6. Loosely secure Mounting Bracket A (item 2) to the rocker panel in the center and rear mounting locations by aligning (item 10) (as shown on figure 5), using (2)M8 Hex bolts (item 14), (2) M8 Lock Washers (item 15), (2) M8 Flat washers (item 16), (1) M10 flat washer (item 9), (1) M10 lock washer (item 8), and (1) M10 Hex nut (item 7). Leave everything loose at this time. **See Figure. 7 & 11.**
7. **Starting from the Passenger side:** Insert (1) M10 bolt/M8 nut plate (item 10) into the rocker panel and thread (1) M10 plastic retainer (item 23) to the M10 bolt to prevent it from falling into the rocker panel. **See Figure. 5.**



Westin Automotive Products, Inc.
320 W. Covina Blvd
San Dimas, Ca. 91773

P.N.: 75-1541-RevA

ECO #: W15-0120

3

Thank You for choosing Westin products
For Additional installation assistance please call
Customer service (800) 793-7846
www.westinautomotive.com

DATE: 12/09/15

8. If the front of the rocker panel has pre-installed M8 riv-certs, the M10/M8 plate (item 10) will need to be positioned as shown in **Figure 8**.
9. If the front rocker panel does not have pre-installed M8 riv-certs then (item 10) will be used as shown on **Figure 5 & 11**.
10. Attach mounting bracket A (item 2) to passenger front and mounting bracket B (item 3) to passenger center and rear using the same procedure as step 6.

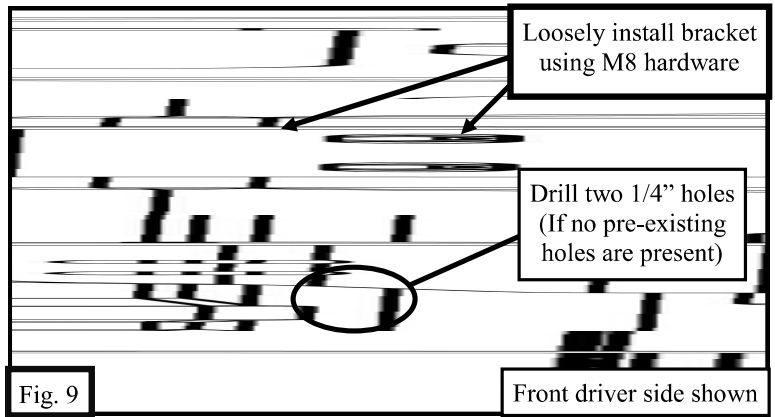
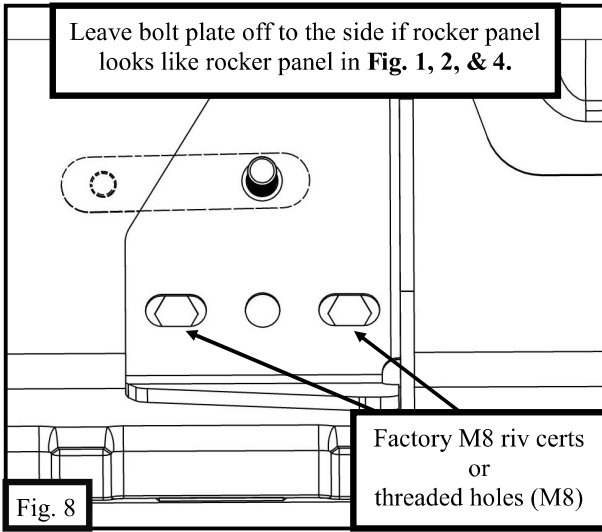

11. If the front of the rocker panel has pre-installed M8 riv-certs, the M10/M8 plate (item 10) will need to be positioned as shown in **Figure 8**.
12. If the front rocker panel does not have pre-installed M8 riv-certs then (item 10) will be used as shown on **Figure 5 & 11**.
13. Attach mounting bracket A (item 2) to passenger front and mounting bracket B (item 3) to passenger center and rear using the same procedure as step 6.

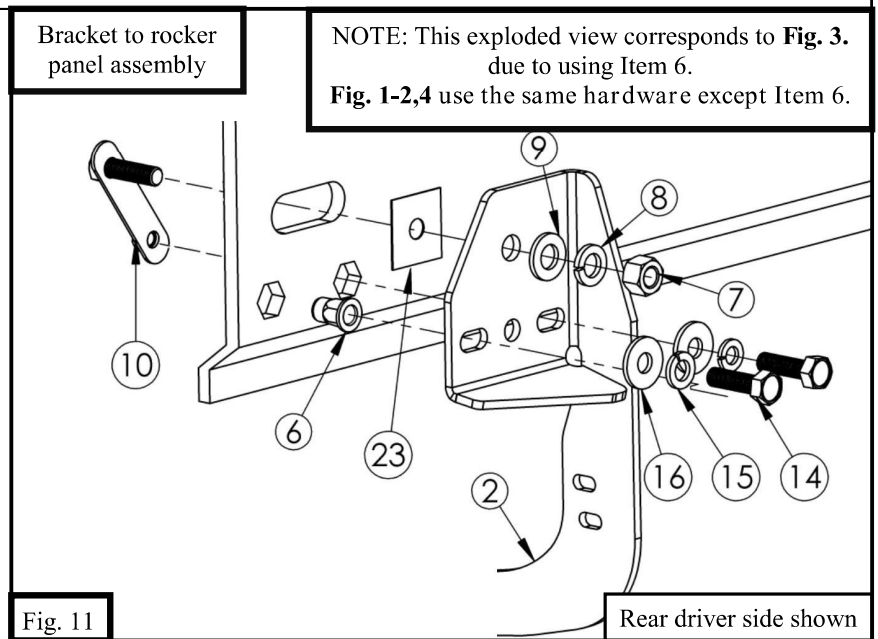
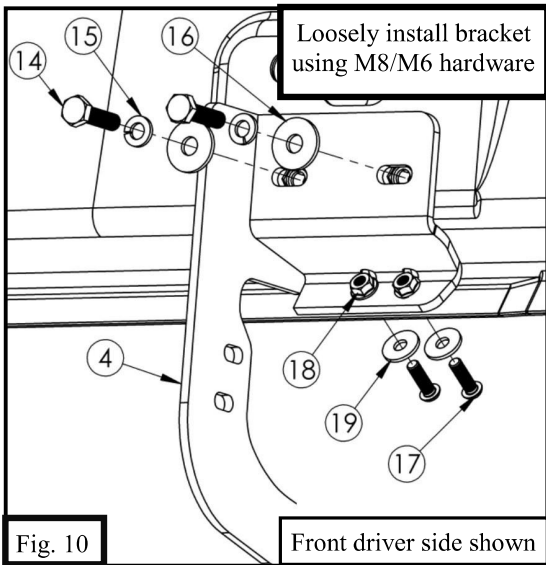

Westin Automotive Products, Inc.
320 W. Covina Blvd
San Dimas, Ca. 91773

14. Locate (1) Plastic Bracket Cover (Item 5) and loosely secure it to the (6) brackets using the provided hardware: (2) M6 hex head bolt, (4) large M6 flat washer, and (2) M6 nylon lock nut (items 11-13). Repeat for every bracket. **See Figure 12.**
15. For Step Board installation to the previously installed mounting brackets use the supplied M8 bolt plates and M8 hardware. Slide bolt plate into the board rail located underneath the step board, then loosely install with M8 hardware. (items 20-22, & item 24). **See Figure 13.**
5. Align and adjust the step bars and brackets as needed, then fully tighten all hardware: M10 to 35 ft-lbs, M8 to 20 ft-lbs, and M6 to 10 ft-lbs.

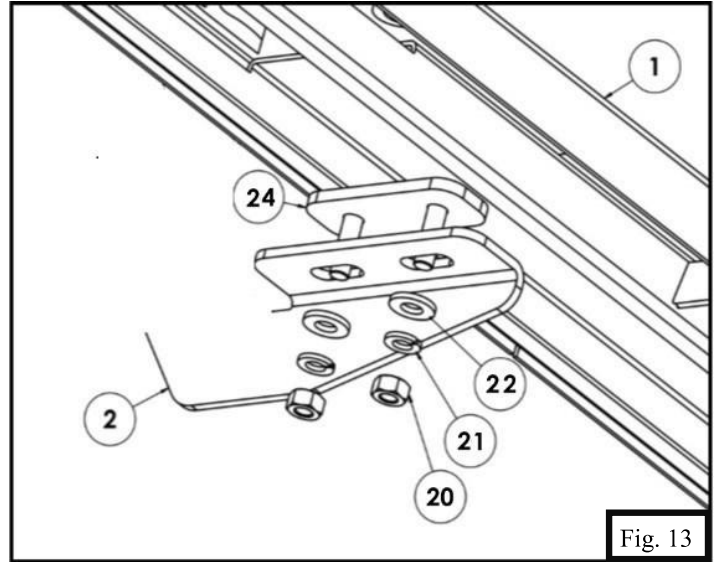
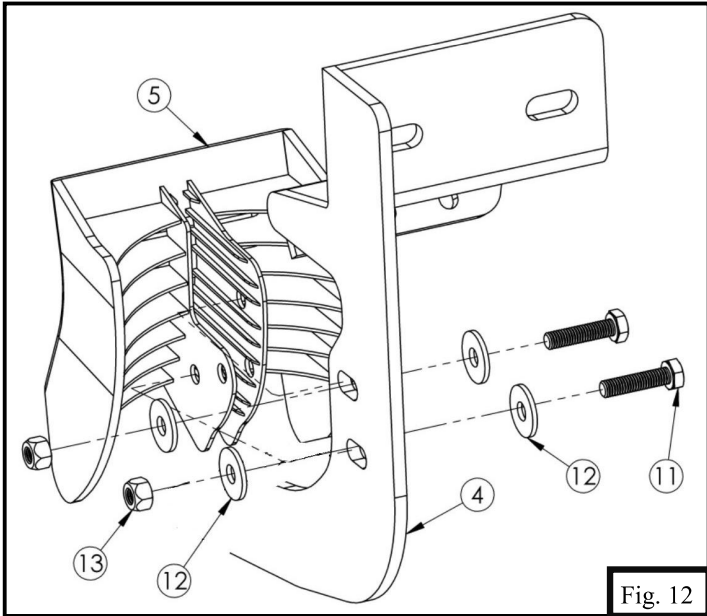

Westin Automotive Products, Inc.
320 W. Covina Blvd
San Dimas, Ca. 91773

P.N.: 75-1541-RevA

ECO #: W15-0120

Thank You for choosing Westin products
For Additional installation assistance please call
Customer service (800) 793-7846
www.westinautomotive.com



DATE: 12/09/15

INSTALLATION COMPLETE



Crew Cab
Shown

Care Instructions

-  REGULAR WAXING IS RECOMMENDED. DO NOT USE ANY TYPE OF POLISH OR WAX THAT MAY CONTAIN ABRASIVES.
-  STAINLESS STEEL PRODUCTS CAN BE CLEANED WITH MILD SOAP AND WATER. STAINLESS STEEL POLISH SHOULD BE USED TO POLISH SMALL SCRATCHES..
-  GLOSS BLACK FINISHES SHOULD BE CLEANED WITH MILD SOAP AND WATER.



Westin Automotive Products, Inc.
320 W. Covina Blvd
San Dimas, Ca. 91773

P.N.: 75-1541-RevA

ECO #: W15-0120

6

Thank You for choosing Westin products
For Additional installation assistance please call
Customer service (800) 793-7846
www.westinautomotive.com

DATE: 12/09/15



SIGNATURE OF QUALITY

AUTOMOTIVE PRODUCTS, INC.



WARNING



Failure to follow these instructions could lead to death, personal injury, and / or property damage.

FASTENERS:

All Westin supplied fasteners must be utilized and installed in accordance with the installation instructions and apply torque to the specifications as defined. **DOUBLE CHECK ALL FASTENERS BEFORE INITIAL USE, AND PERIODICALLY IN THE FUTURE TO ENSURE PROPER FUNCTION AND SAFETY.**

DRILLING:

Most Westin products do not require drilling for installation. If drilling is defined as required, use caution when drilling a vehicle. **FAILURE TO REVIEW AN AREA TO BE DRILLED MAY RESULT IN PERSONAL INJURY AND/OR INJURY TO OTHERS AS WELL AS VEHICLE DAMAGE.**

EYE PROTECTION:

ALWAYS WEAR SAFETY GLASSES OR GOGGLES DURING THE INSTALLATION PROCESS TO AVOID PERSONAL INJURY.

MAXIMUM TOWING/CARRYING CAPACITY:

The Westin Receiver Hitches will have a visible tow rating label affixed directly on the product. User should never exceed the vehicle manufacturers maximum tow and weight rating regardless of the capacity of the hitch. **FAILURE TO FOLLOW THESE GUIDELINES WILL VOID THE WESTIN WARRANTY AND MAY RESULT IN PERSONAL INJURY AND/OR INJURY TO OTHERS AS WELL AS VEHICLE DAMAGE.**



Westin Automotive Products, Inc.
320 W. Covina Blvd
San Dimas, Ca. 91773

P.N.: 75-1541-RevA

ECO #: W15-0120

7

Thank You for choosing Westin products
For Additional installation assistance please call
Customer service (800) 793-7846
www.westinautomotive.com

DATE: 12/09/15